



E I C H H O L T Z

112071 CHANDELIER TORTORA ANTIQUE BRASS FINISH

ASSEMBLY INSTRUCTION

- 1** Turn-off the electricity supply at main circuit panel before installing. Do not connect electricity supply until your ceiling light is fully assembled and installed.  
Determine the desired height of your chandelier and connect the extension pipes.

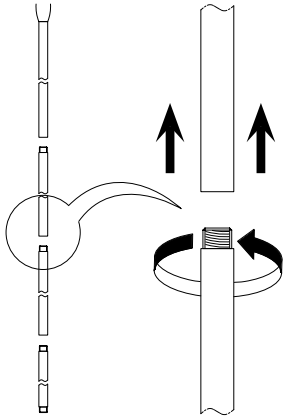

- 2** Thread the wire from the lamp through the pipe.

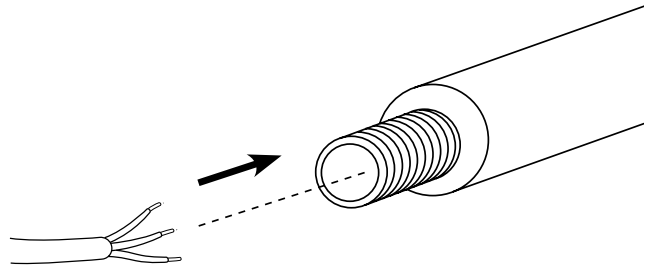

- 3** Fix the ceiling plate (A) to the ceiling by using mounting plugs and screws suitable to your ceiling type. Guide the wires through the plate. Place or hold the lamp in an elevated position in such a way that the wires can freely reach the ceiling junction box.

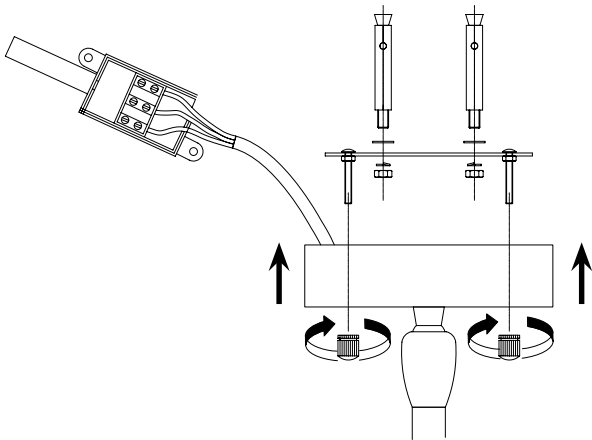

- 4** Connect the 3 power wires according to their colours. Brown is the live wire, blue is the neutral wire, green/yellow is the earth wire. Place the ceiling canopy (B) flush against the ceiling and fix it securely with the two nuts supplied.

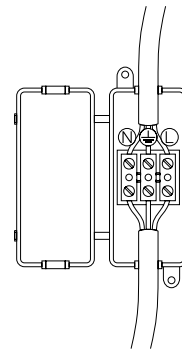

- 5** Put the arms in to the lamp frame, fix them with the allen screws.

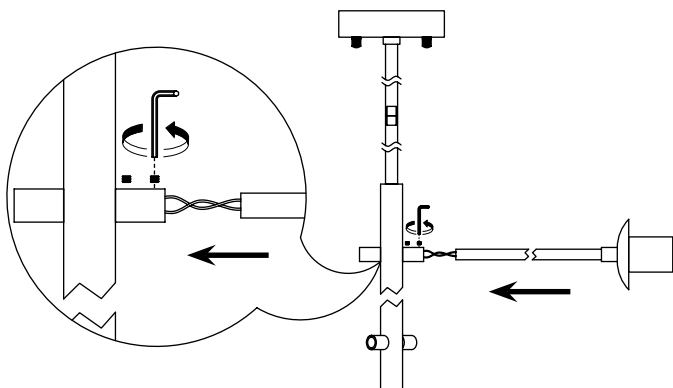

- 6** Place the bulbs.

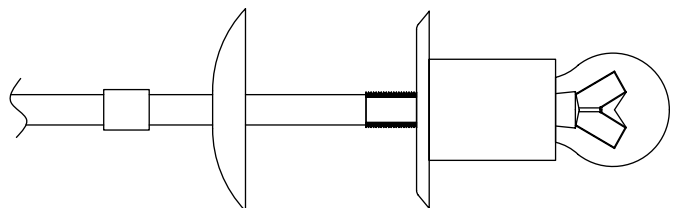



E I C H H O L T Z

112071 CHANDELIER TORTORA ANTIQUE BRASS FINISH

ASSEMBLY INSTRUCTION

**7** Place the glass lampshade over the lampholder by tilting it around the gap in the plate and rotating it.

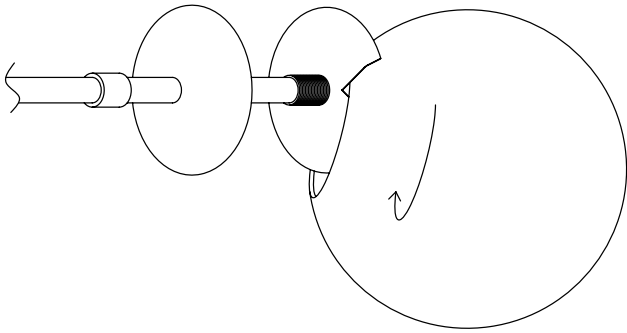

**8** Align the glass lampshade with the lamp holder. Fix the glass by tightening the nut.

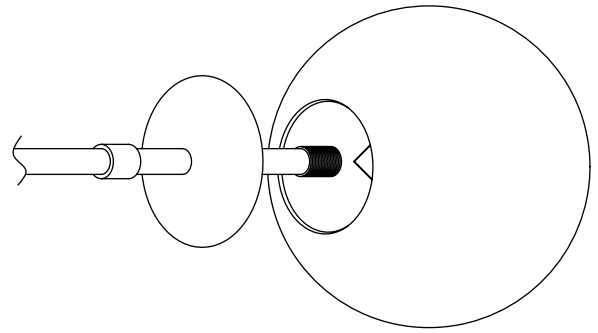

**FINAL**

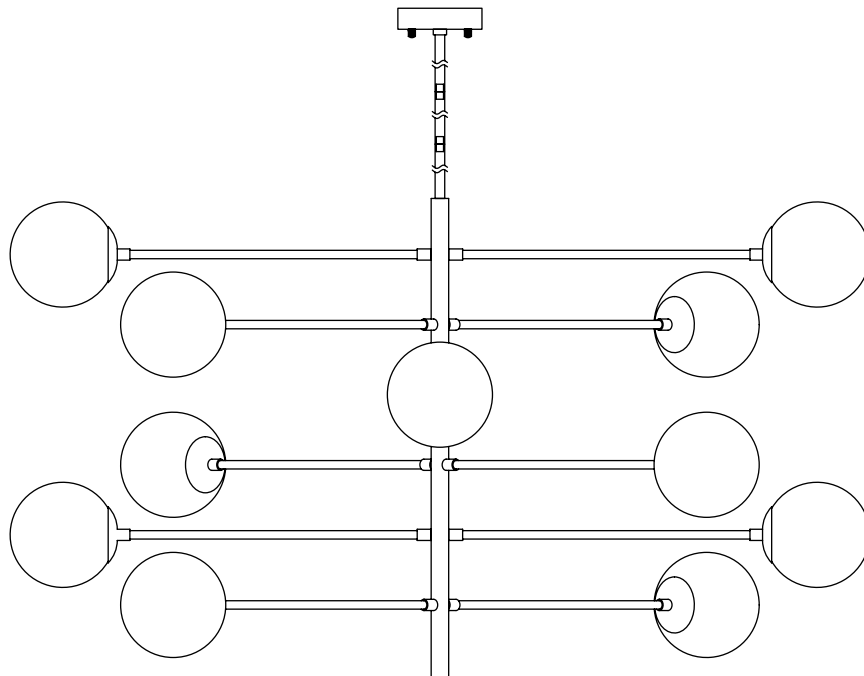

**CARE INSTRUCTION**

Wipe clean with soft, dry cloth.  
Always avoid the use of harsh chemicals or abrasive cleaners  
as they may cause damage to the fixture's finish.