

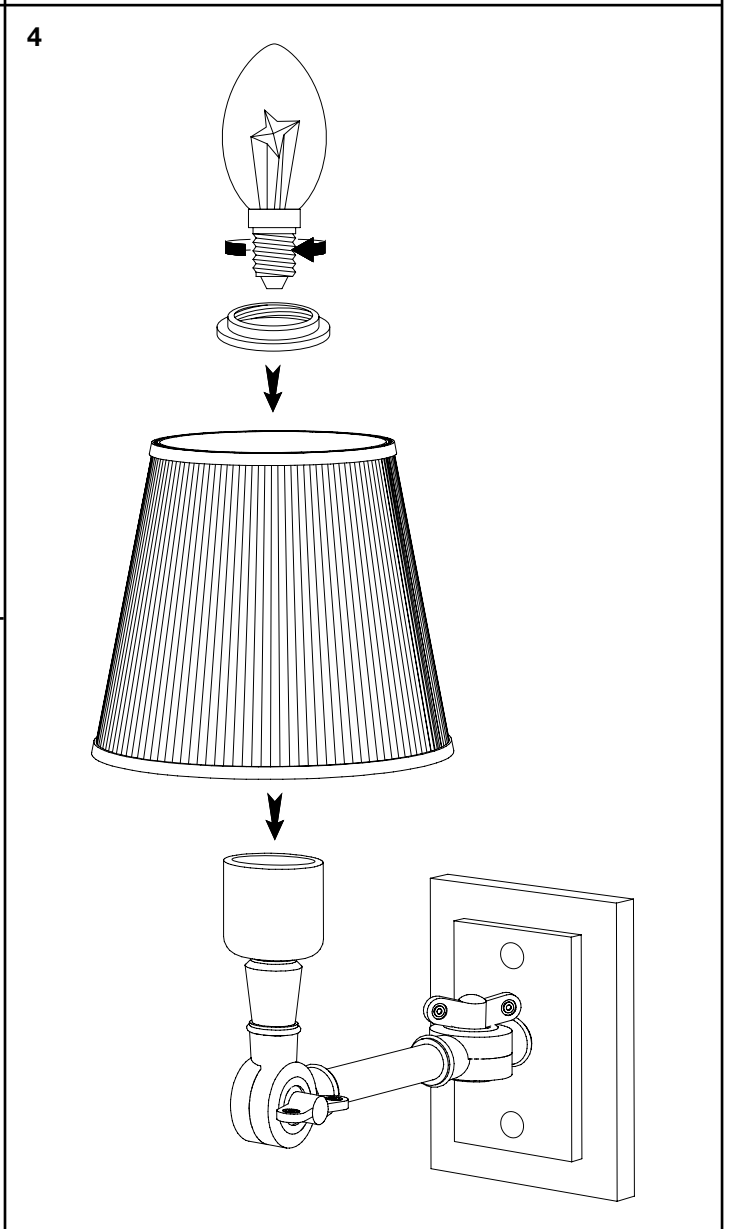

E I C H H O L T Z

107174 WALL LAMP WENTWORTH SINGLE

ASSEMBLY INSTRUCTION

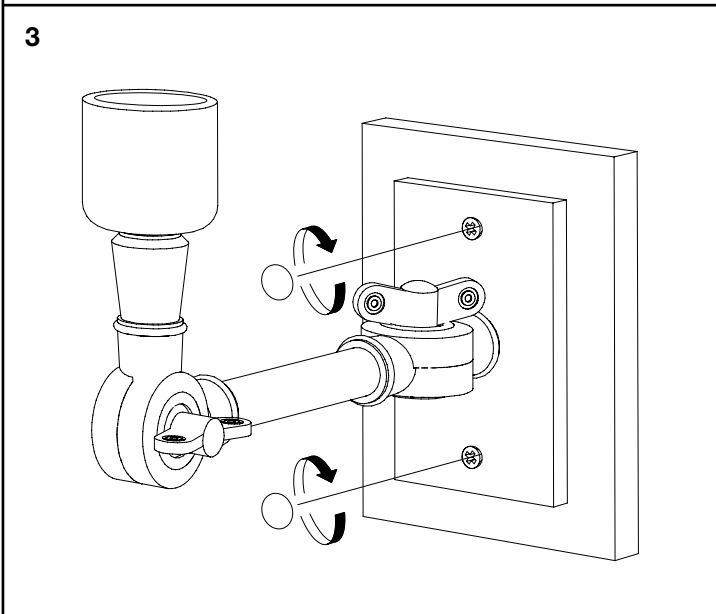
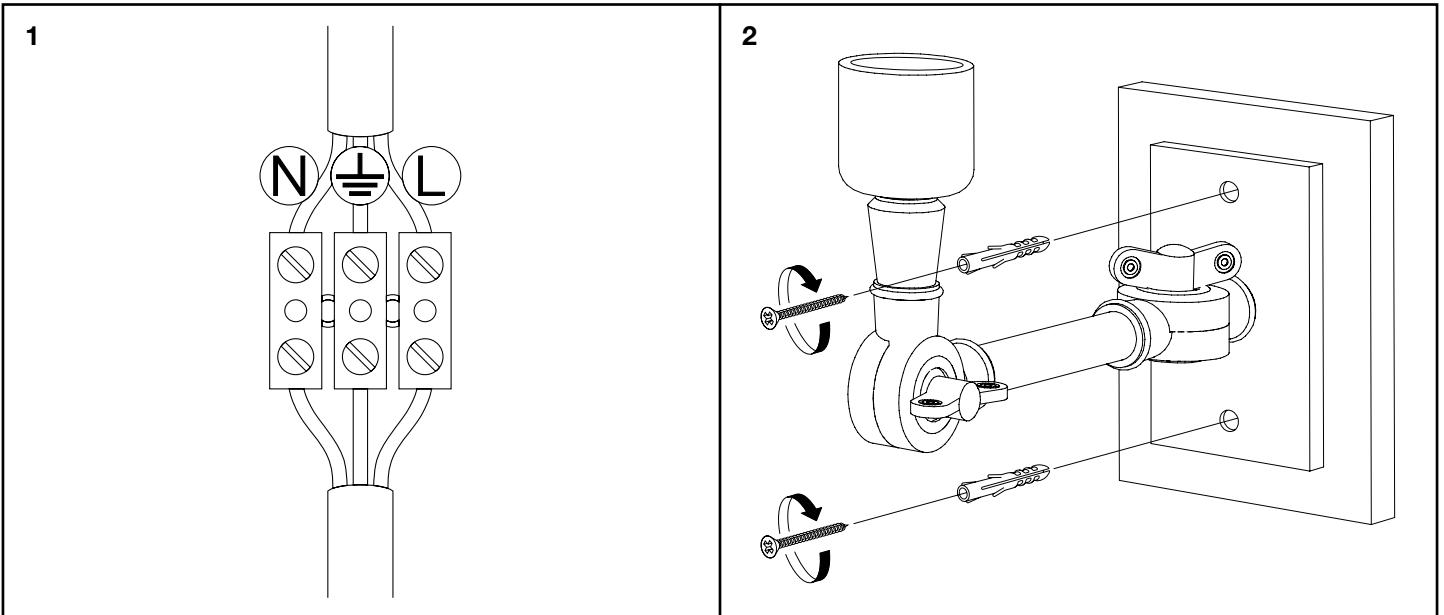

Turn off the electricity supply at the main circuit panel before installing.
Do not connect the electricity supply until your luminaire is fully assembled and installed.

Fix the lamp to the wall by using wall mounting plugs and screws suitable to your wall type.

Connect the 3 wires according to their colours. Brown is the live wire, blue is the neutral wire, green/yellow is the earth wire.

Place the bulbs and the shade.